

k -元 n -立方體上之泛連接性質及泛迴圈性質

Panconnected properties and pancyclic properties of the k -ary n -cubes

方覺非^{1,*}

Jywe-Fei Fang

馮士丞¹

Shr-Cheng Feng

黃玉潔²

Yu-Chieh Huang

¹ 國立台中教育大學

數位內容科技系

Department of Digital Content and

Technology

National Taichung University

* jffang@mail.sju.edu.tw

² 國立台中教育大學

資訊科學系

Department of Computer and

Information Science

National Taichung University

摘要

在本論文中，我們研究了 k -元 n -立方體上之泛迴圈性質及泛連接性質。當 k 為偶數且 $n \geq 2$ 時，我們證明了 k -元 n -立方體具有剩餘雙沉連接性(residual bipanconnected)。也就是說此類的 k -元 n -立方體具有雙沉連接性(bipanconnected)；並且對於屬於相同雙分子集(bipartite set)的任兩結點 X 及 Y ，不但存在任意由 $Dist(X, Y)$ 至 $N-2$ 偶長度之路徑連接之，並且存在一個剩餘結點 Z 相鄰接，其中 N 為此圖結點數， $Dist(X, Y)$ 標示 X 和 Y 的最短距離。而且，我們還證明了當 k 為偶數及 $n \geq 2$ 時， k -元 n -立方體具有沉雙迴圈性質(bipancyclic)。

而對於奇數的 k 及 $n \geq 2$ 時， k -元 n -立方體也被證明具有嚴格 m -沉連接性質(strictly m -panconnected)，而其 m 值為 $(k-1)n/2$ 。也就是說，對任兩結點 X 及 Y ，存在任意由 $(k-1)n/2$ 至 $N-1$ 長度之路徑連接之；而且 $(k-1)n/2$ 已經達到了此問題之理論下限。我們也證明了當 k 為大於等於 5 的奇數且 $n \geq 2$ 時， k -元 n -立方體具有嚴格 m -沉迴圈性質(strictly m -pancyclic)，而其 m 值為 $k-1$ 。也就是說，它包含了所有介於 $k-1$ 到 N 的迴圈，而且 $k-1$ 已達該問題之理論下限了。

關鍵字：連結網路， k -元 n -立方體，泛迴圈性質及泛連接性質。

1. Introduction

A Path and a cycle are popular interconnection networks owing to their simple structures and low

degrees. Moreover, many parallel algorithms have been devised on them [8, 10]. Many researchers have discussed how to embed cycles and paths into various interconnection networks [2, 5, 6]. To execute a parallel program on a path efficiently, the size of the path must accord with the problem size of the program [8]. Therefore, it makes sense to discuss how to join a specific pair of vertices by paths of various sizes. A graph G with N vertices is *panconnected* if for each pair of distinct vertices X, Y and for any integer l , where $Dist(X, Y) \leq l \leq N-1$, there exists a path of length l joining X and Y , where $Dist(X, Y)$ is the distance between X and Y [5].

A graph is m -panconnected if each pair of vertices X and Y is joined by the m -panconnected paths of all lengths ranging from m to $N-1$. Clearly, every m_1 -panconnected graph must be m_2 -panconnected, where $N-1 \geq m_2 \geq m_1$. A graph is *strictly m -panconnected* if it is m -panconnected but not $(m-1)$ -panconnected; that is, m has reached the lower bound of the problem.

The *bipanconnectivity* is a restriction of the concept of the panconnectivity to bipartite graphs [9]. A bipartite graph is said to be bipanconnected if there exists a *bipanconnected path* of each length s joining an arbitrary pair of vertices X and Y for each $dist(X, Y) \leq s \leq N-1$, where $s-dist(X, Y)$ is even and $dist(X, Y)$ is the distance between X and Y . The *residual vertex* that is not contained in the bipanconnected path joining X and Y is denoted by $RV(X, Y)$. A bipartite graph G is *residual bipanconnected* if G is *bipanconnected*; and for arbitrary two vertices X and Y reside in the same partite set of G , there exists a residual vertex $RV(X, Y)$ adjacent to Y . That is, for arbitrary two vertices X and Y in the same bipartite set, there exists a path of each odd length $s+1$, ($X=V_0, V_1, \dots, V_s = Y, V_{s+1} = RV(X, Y)$), for each $dist(X, Y) \leq$

$s \leq N-1$.

Likewise, to execute a parallel program efficiently, the size of the allocated cycle must also accord with the problem size of the program. Thus, many researchers study the problem of how to embed cycles of different sizes into an interconnection network. A graph is *pancyclic* if it embeds a cycle of every length ranging from 3 to N [2]. A graph is *m-pancyclic* if it embeds a cycle of every length ranging from m to N , where $3 \leq m \leq N$. Obviously, every m_1 -pancyclic graph must be m_2 -pancyclic, where $N \geq m_2 \geq m_1$. A graph is *strictly m-pancyclic* if it is not $(m-1)$ -pancyclic but m -pancyclic; that is, m has reached the lower bound of the problem. The *bipancyclicity* is a restriction of the concept of pancyclicity to bipartite graphs. A bipartite graph is bipancyclic if it embeds a cycle of every even length ranging from 4 to N .

In a *heterogeneous computing system*, each vertex and each edge may be assigned with distinct computing power and distinct bandwidth, respectively [13]. Thus, it is meaningful to extend the pancyclicity to the *vertex-pancyclicity* and the *edge-pancyclicity* [6]. A graph is vertex-pancyclic (edge-pancyclic) if each vertex(edge) lies on a cycle of every length ranging from 3 to N . Informally, a vertex(edge) transitive graph looks the same when viewed from each vertex(edge). Clearly, an m -pancyclic graph must be m -vertex-pancyclic (m -edge-pancyclic) if it is vertex(edge) transitive. Similarly, that a bipancyclic graph possesses vertex transitivity(edge transitivity) implies that it is a vertex-bipancyclic (edge-bipancyclic) graph.

The interconnection network considered in this paper is the k -ary n -cube which is denoted by an $H(k, n)$. Many interconnection networks, including the *ring*, the *torus* and the *hypercube*, can be viewed as the subclasses of the k -ary n -cubes [7]. These interconnection networks are attractive in both theoretical interests and practical systems [8]. In fact, they are widely applied as the interconnection networks of some practical systems. For example, Kendall square machines have ring structure [7], the Tera Parallel Computer [14] and CRAY T3D [12] use the 2D torus and the 3D torus as their interconnection networks, respectively. The Symult S-series [1] and NCUBE family [11] employ the hypercube as their interconnection networks.

On the other hand, the $H(k, n)$ has been proved to possess many attractive properties such as regularity, vertex transitivity and edge transitivity [3]. For example, Bose et al. shown that it is Hamiltonian; and they proposed a single-vertex routing algorithm and a broadcasting algorithm [4]. Ashir et al. devised several communication algorithms including multi-vertex broadcasting, single-vertex scattering and total exchange [3]. Yang et al. investigated the fault tolerant Hamiltonicity [16]. Wang et al. studied some Hamiltonian-like properties, such as

bipancyclic, laceability and bipanconnectivity, of the $H(k, n)$ [15]. They have shown that the $H(k, 2)$ is bipancyclic and Hamiltonian laceable for k is even.

In this paper, We do a further investigation about the bipanconnectivity and m -panconnectivity of the $H(k, n)$. We refer to the $H(k, n)$ for k is even(odd) as the *even(odd) $H(k, n)$* . We prove that the *even $H(k, n)$* is residual bipanconnected for $n \geq 2$. The odd $H(k, n)$ is shown to be strictly m -panconnectic where $m = n(k-1)/2$, for $k \geq 3$ and $n \geq 2$. That is, there exist a path of each length ranging from $n(k-1)/2$ to $N-1$ and $n(k-1)/2$ has reached the lower bound of this problem. We also show that the k -ary n -cube is bipancyclic for k is even and $n \geq 2$. That is, it embeds all cycles of even lengths ranging from 4 to N , where N is the order of the network. The k -ary n -cube is shown to be strictly m -pancyclic where $m = k-1$, for k is odd, $k \geq 5$ and $n \geq 2$. That is, it embeds all cycles of lengths ranging from $k-1$ to N and the value $k-1$ has reached the lower bound of this problem.

2. Notations and Background

A path of length l_1 is denoted by a $P(l_1)$; and a cycle of length l_2 is denoted by a $C(l_2)$ where $l_2 \geq 3$. A ladder of length s , denoted by an $L(s)$, is a $P(s) \times K(2)$ where $K(2)$ is a two-vertex complete graph that is an edge. Each vertex of an $L(s)$ is labeled by (b_1, b_0) , where $b_0 = 0$ or $b_0 = 1$, and $0 \leq b_1 \leq s$. Each edge $((b_1, 0), (b_1, 1))$ is called a *rung* of the $L(s)$, where $0 \leq b_1 \leq s$. Specifically, it is called the b_1 th rung. The 0th rung is called the *bottom rung* of the ladder. As shown in Figure 1, an $L(6)$ is illustrated. In this paper, we use $\{(0, 0), (1, 0), \dots, (s, 0), (s, 1), \dots, (1, 1), (0, 1)\}$ to denote the $L(s)$. Clearly, a path of length $2l+1$, $((0, 0), (1, 0), \dots, (l, 0), (l, 1), \dots, (1, 1), (0, 1))$, can be embedded in an $L(s)$, where $0 \leq l \leq s$.

Definition 1. A torus with r rows and c columns, denoted by a $Tor(R, F)$, is defined as $C(R) \times C(F)$.

A vertex of a $Tor(R, F)$ is labeled by (v_2, v_1) , where $0 \leq v_2 \leq R-1$, $0 \leq v_1 \leq F-1$.

Proposition 1. There exists a path of each odd length ranging from 1 to $2s+1$ joining $(0, 0)$ and $(0, 1)$ in an $L(s)$. Thus, there exists a cycle of each even length ranging from 4 to $2s+2$ containing $((0, 0), (0, 1))$.

Definition 2. The k -ary n -cube, denoted by the $H(k, n)$, is defined recursively [4]:

1. An $H(k, 1)$ is a $C(k)$.
2. An $H(k, n)$ is $H(k, n-1) \times C(k)$ for $n \geq 2$.

That is, an $H(k, n)$ is a $C(k)^n$. An $H(k, n)$ comprises k^n vertices, each vertex X labeled by an n -digit number in radix k arithmetic $v_n v_{n-1} \dots v_2 v_1$. The vertex $X = v_n v_{n-1} \dots v_{i+1} v_i v_{i-1} \dots v_2 v_1$ is adjacent to another vertex $Y = v_n v_{n-1} \dots v_{i+1} w_i v_{i-1} \dots v_2 v_1$ if and

only if they differ by exactly one digit position i and $|v_i - w_i| = 1$, where $1 \leq i \leq n$. A digit v_i is an *even(odd) digit* if it is even(odd). A vertex $X = v_n v_{n-1} \dots v_{i+1} v_i v_{i-1} \dots v_2 v_1$ is an *even(odd) vertex* if the sum of its all digits is even(odd). The $H(k, n)$ is a bipartite graph for k is even because the odd(even) vertices are just adjacent to even(odd) vertices. The $H(k, n)$ possesses many attractive properties:

Proposition 2. The $H(k, n)$ is Hamiltonian. [4]

Proposition 3. The $H(k, n)$ is vertex transitive and edge transitive. [3]

Definition 3. Let $A = a_n a_{n-1} \dots a_2 a_1$ be an n -digit radix k number. The *Lee weight* of A , denoted by $W_L(A)$, is defined as

$$W_L(A) = \sum_{i=1}^n |a_i|, \text{ where } |a_i| = \min(a_i, k-a_i) \quad [4]$$

Definition 4. The *Lee distance* between two n -digit radix k numbers A and B is defined as $W_L(A-B)$. [4]

Proposition 4. The distance of two vertices X and Y , denoted by $Dist(X, Y)$, is $W_L(X-Y)$. [4]

Since an even $H(k, n)$ is bipartite, all of the lengths of the paths joining two vertices X and Y of the even $H(k, n)$ are even or odd; whereas, the paths joining two vertices X and Y of an odd $H(k, n)$ have even lengths or odd lengths. The *odd(even) distance* of two vertices X and Y in the odd $H(k, n)$, denoted by $ODist(X, Y)$ ($EDist(X, Y)$), is the length of the path with the shortest odd(even) length joining X and Y . If $W_L(X-Y)$ is an odd number; clearly, the $ODist(X, Y) = Dist(X, Y)$; otherwise, $EDist(X, Y) = Dist(X, Y)$.

A path of an $H(k, n)$ can be represented by its *transition sequence* which is the ordered list of each digit position associated with the direction (i.e., + or -) that change as it proceeds from one vertex to the next one. For example, the path of the $H(5, 4)$, (2314, 2324, 2224, 3224, 3223, 3213), can be represented by (2+, 3-, 4+, 1-, 2-). Clearly, that the transition sequence of a path contains both of $i+$ transition and $i-$ transition implies that it is not shortest; because it can be shortened by reducing a pair of $i+$ transition and $i-$ transition. We have

Proposition 5. The transition sequence of an $ODist(X, Y)$ or an $EDist(X, Y)$ contains only $i+$ transition or $i-$ transition for each $1 \leq i \leq n$.

By Proposition 4, we know that the transition sequence of a shortest path joining X and Y contains the shorter transition hops generated by either $i+$ transitions or $i-$ transitions for each $1 \leq i \leq n$. Consider two vertices in a $C(l)$. Let the length of the shortest path joining the two vertices be f ; then, the length of the converse path is $l-f$. That is, the converse path takes $l-2f$ more hops than the shortest path. Given two vertices $X = v_n v_{n-1} \dots v_2 v_1$ and $Y = u_n u_{n-1} \dots u_2 u_1$ of an $H(k, n)$, if we choose the transition direction (i.e., $i+$ transition or $i-$ transition) which generates the longer

transition hops for some dimension i , and we choose the transition direction which generates the shorter transition hops except dimension i , there exists $Dist(X, Y) + k - 2Min(k - v_i + u_i, v_i - u_i)$ hops in the path joining X and Y . If k is odd and $Dist(X, Y)$ is even(odd), $Dist(X, Y) + k - 2Min(k - v_i + u_i, v_i - u_i)$ is odd(even); whereas if k is even and $Dist(X, Y)$ is even(odd), $Dist(X, Y) + k - 2Min(k - v_i + u_i, v_i - u_i)$ is even(odd). To minimize $k - 2Min(k - v_i + u_i, v_i - u_i)$ for each $1 \leq i \leq n$, clearly, the maximum of $Min(k - v_i + u_i, v_i - u_i)$ should be chosen. Thus, we have

Proposition 6. Given two vertices $X = v_n v_{n-1} \dots v_2 v_1$ and $Y = u_n u_{n-1} \dots u_2 u_1$ of an odd $H(k, n)$ and let $Dist(X, Y) = ODist(X, Y)$ (Respectively, $EDist(X, Y)$), the $EDist(X, Y)$ (Respectively, $ODist(X, Y)$) is $Dist(X, Y) + k - 2Max(Min(k - v_i + u_i, v_i - u_i))$ for each $1 \leq i \leq n$.

In this paper, the *outline graph* of an $H(k, n)$, denoted by an $OG(H(k, n))$, is to take each $v_n v_{n-1} \dots v_2 v_1$ subnetwork as a supervertex, where $*$ is a don't care symbol; and a pair of supervertices V^* and U^* in the $OG(H(k, n))$ is connected if and only if there exists an edge (X_1, X_2) in the $H(k, n)$ such that X_1 is in the V^* and X_2 is in the U^* . Clearly, a pair of supervertices $V^* = v_n v_{n-1} \dots v_2 v_1$ and $U^* = u_n u_{n-1} \dots u_2 u_1$ is connected if and only if they differ by exactly one digit position, the i th digit where $2 \leq i \leq n$, and $|v_i - u_i| = 1$. That is, if each $v_n v_{n-1} \dots v_2 v_1$ subnetwork of an $H(k, n)$ is taken as a supervertex, the $H(k, n)$ will be transformed to an $H(k, n-1)$. We have the following proposition.

Proposition 7. The $OG(H(k, n))$ is an $H(k, n-1)$.

The vertex $X = v_n v_{n-1} \dots v_2 d$ is called the vertex d of the $V^* = v_n v_{n-1} \dots v_2 v_1$. By the structure of the $H(k, n)$, the vertex d of V^* and vertex d of U^* are adjacent if and only if V^* and U^* are adjacent in the $OG(H(k, n))$ for each $0 \leq d \leq k-1$. Clearly, if the $OG(H(k, n))$ embeds a $C(l)$, ($V_0^*, V_1^*, V_2^*, \dots, V_{l-1}^*$), the $H(k, n)$ embeds the structure of $C(l) \times C(k)$. Likewise, if the $OG(H(k, n))$ embeds a $P(l)$, ($V_0^*, V_1^*, V_2^*, \dots, V_{l-1}^*, V_l^*$), the $H(k, n)$ embeds the structure of $P(l) \times C(k)$. As illustrated in Figure 2, the structure of $C(l) \times C(k)$ is embedded in $H(k, n)$ if $C(l)$ is embedded in $OG(H(k, n))$.

Definition 5. A path-of-ladders $POL(BP, sl, LD(0), LD(1), \dots, LD(sl-1))$ is a graph unified by a *bone path* BP and sl ladders $LD(0), LD(1), \dots, LD(sl-1)$ with $BR(0), BR(1), \dots, BR(sl-1)$ as the bottom rungs, respectively, such that each $BR(i)$ is contained in the BP where $0 \leq i \leq sl-1$.

As illustrated in Figure 3, the structure of a path-of-ladders graph is shown, where $(x_0, x_1, x_2, x_3, x_4, x_5)$ is the bone path; and $(x_0, x_1), (x_1, x_2), (x_2, x_3), (x_4, x_5)$ are $BR(0), BR(1), BR(2)$ and $BR(3)$, respectively. From Proposition 1, we have

Proposition 8. A path-of-ladders $POL(BP, sl, LD(0), LD(1), \dots, LD(sl-1))$ contains a path of each length l joining two ends of BP , where $l_{bp} \leq l \leq N-1$ and $l-l_{bp}$

is even, lbp is the length of BP .

Definition 6. A cycle-of-ladders $COL(BC, sl, LD(0), LD(1), \dots, LD(sl-1))$ is unified by a bone cycle BC and sl ladders $LD(0), LD(1), \dots, LD(sl-1)$ with $BR(0), BR(1), \dots, BR(sl-1)$ as the bottom rungs, respectively, such that each $BR(i)$ is contained in the BC where $0 \leq i \leq sl-1$ and $BR(0), BR(1), \dots, BR(sl-1)$ disjoint each other.

As illustrated in Figure 3, the structure of a cycle-of-ladders graph is shown, where $(x_0, x_1, x_2, x_3, x_4, x_5)$ is the bone cycle; and $(x_0, x_1), (x_2, x_3)$ are the $BR(0), BR(1)$, respectively. By Proposition 1, we have

Proposition 9. A cycle-of-ladders $COL(BC, sl, LD(0), LD(1), \dots, LD(sl-1))$ contains a cycle of each length l , where $lbc \leq l \leq N$ and $l-lbc$ is an even number, lbc is the length of BC and N is the number of vertices of the cycle-of-ladders.

3. Panconnected Properties of the $H(k, 2)$

In this section, we study how to embed paths into the k -ary n -cubes. Firstly, we study the path embedding properties of the $H(k, 2)$. Since the $H(k, 2)$ is a $Tor(k, k)$, to clarify the labeling of each vertex, we will discuss these properties on the $Tor(k, k)$.

Lemma 1. Let $X = (0, 0)$ and $Y = (v_2, v_1)$ be two vertices of a $Tor(R, F)$. There exist the paths of all lengths l where $l-v_2-v_1$ is even, $v_2+v_1 \leq l \leq v_2R+v_1$ for even v_2 , and $v_2+v_1 \leq l \leq v_2R+R-v_1-1$ for odd v_2 .

Proof.

Case 1. v_2 is odd. Firstly, Unify the bone path $BP = ((0, 0), (0, 1), \dots, (0, v_1-1), (0, v_1), (1, v_1), (2, v_1), \dots, (v_2-1, v_1), (v_2, v_1))$ with the v_2 ladders, $LD(0) = ((0, v_1), (0, v_1+1), \dots, (0, R-2), (0, R-1), (1, R-1), (1, R-2), \dots, (1, v_1+1), (1, v_1))$, $LD(1) = ((1, v_1), (1, v_1-1), \dots, (1, 1), (1, 0), (2, 0), (2, 1), \dots, (2, v_1-1), (2, v_1))$, \dots , $LD(v_2-2) = ((v_2-2, v_1), (v_2-2, v_1-1), \dots, (v_2-2, 1), (v_2-2, 0), (v_2-1, 0), (v_2-1, 1), \dots, (v_2-1, v_1-1), (v_2-1, v_1))$, $LD(v_2-1) = ((v_2-1, v_1), (v_2-1, v_1+1), \dots, (v_2-1, R-2), (v_2-1, R-1), (v_2, R-1), (v_2, R-2), \dots, (v_2, v_1+1), (v_2, v_1))$ the $POL(BP, v_2, LD(0), LD(1), \dots, LD(v_2-1))$ can be generated. By Proposition 8, the paths joining X and Y of all lengths ranging from v_2+v_1 to v_2R+R-v_1-1 can be derived, where $l-v_2-v_1$ is even. As illustrated in Figure 4, we show the pol_2 for the case that $(v_2, v_1) = (3, 2)$ of the $Tor(8, 8)$.

Case 2. v_2 is even. Similar to Case 1, we can prove that the paths joining X and Y of all lengths ranging from v_2+v_1 to v_2R+v_1 , where $l-v_2-v_1$ is even, can be derived. Q. E. D.

The snake path joining $(0, 0)$ and (v_2, v_1) is the path with the maximal length (i.e., v_2R+v_1 for odd v_2 , and v_2R+R-v_1-1 for even v_2) in the above lemma.

Lemma 2. The even $H(k, 2)$ is residual bipanconnected.

Proof. By the symmetric properties of the $H(k, 2)$, without loss of generality, let $X = (0, 0)$ and $Y = (v_2, v_1)$ where $k/2 > v_2, v_1 \geq 0$.

Case 1. X and Y are in the distinct partite sets. That is, v_2+v_1 is odd. One of v_2 and v_1 is an odd number and the other one is an even number. Without loss of generality, let v_1 and v_2 be an even number and an odd number, respectively. By Lemma 1, there exist the paths of all odd lengths ranging from v_2+v_1 to v_2k+k-v_1-1 joining X and Y . Unify the bone path BP which is the snake path joining $(0, 0)$ and (v_2, v_1) with the $k/2$ ladders, $LD(0) = ((v_2-1, 0), (v_2, 0), \dots, (k-1, 0), (k-1, 1), \dots, (v_2, 1), (v_2-1, 1))$, \dots , $LD(i) = ((v_2-1, v_1-2), (v_2, v_1-2), \dots, (k-1, v_1-2), (k-1, v_1-1), \dots, (v_2, v_1-1), (v_2-1, v_1-1))$, $LD(i+1) = ((v_2, v_1), (v_2+1, v_1), \dots, (k-1, v_1), (k-1, v_1+1), \dots, (v_2+1, v_1+1), (v_2, v_1+1))$, \dots , and $LD(k/2-1) = ((v_2, k-2), (v_2+1, k-2), \dots, (k-1, k-2), (k-1, k-1), \dots, (v_2+1, k-1), (v_2, k-1))$, a $POL(BP, k/2, LD(0), LD(1), \dots, LD(k/2-1))$ can be derived, where $i = v_1/2-1$. As illustrated in Figure 5, the case that $(v_2, v_1) = (3, 2)$ of the $Tor(8, 8)$ is shown. By Proposition 8, there are paths of all odd lengths ranging from v_2k+k-v_1-1 to k^2-1 joining X and Y . Combining the result of Lemma 1, we know that there exist the paths joining X and Y of all odd lengths ranging from v_2+v_1 to k^2-1 .

Case 2. X and Y are in the same partite set. That is, both of v_2 and v_1 are odd numbers or even numbers.

Case 2.1. v_2 and v_1 are even numbers. By Lemma 1, we know that there exist paths joining $X = (0, 0)$ and $Y = (v_2, v_1)$ of all even lengths ranging from v_2+v_1 to v_2k+v_1 . In the first stage, let BP_1 be the snake path joining X and Y , and let $LD_1(0) = ((v_2-1, k-1), (v_2, k-1), \dots, (k-1, k-1), (k-1, k-2), \dots, (v_2, k-2), (v_2-1, k-2))$, $LD_1(1) = ((v_2-1, k-3), (v_2, k-3), \dots, (k-1, k-3), (k-1, k-4), \dots, (v_2, k-4), (v_2-1, k-4))$, \dots , $LD_1(i) = ((v_2-1, v_1+3), (v_2, v_1+3), \dots, (k-1, v_1+3), (k-1, v_1+2), \dots, (v_2, v_1+2), (v_2-1, v_1+2))$, where $i = (k-1-(v_1+3))/2 = (k-v_1)/2-2$; and let $LD_1(i+1) = ((v_2, 0), (v_2+1, 0), \dots, (k-1, 0), (k-1, 1), \dots, (v_2+1, 1), (v_2, 1))$, $LD_1(i+2) = ((v_2, 2), (v_2+1, 2), \dots, (k-1, 2), (k-1, 3), \dots, (v_2+1, 3), (v_2, 3))$, \dots , $LD_1(k/2-2) = ((v_2, v_1-2), (v_2+1, v_1-2), \dots, (k-1, v_1-2), (k-1, v_1-1), \dots, (v_2+1, v_1-1), (v_2, v_1-1))$. Unify BP_1 with the above ladders, a $pol_1 = POL(BP_1, k/2-1, LD_1(0), LD_1(1), \dots, LD_1(k/2-2))$ can be derived. As illustrated in Figure 6, the case that $(v_2, v_1) = (2, 4)$ of the $Tor(8, 8)$ is shown. By Proposition 8, we can obtain the paths joining X and Y of all even lengths ranging from v_2+v_1 to v_2k+v_1 to $v_2k+v_1+2(i+1)(k-v_2)+2(k/2-2-i)(k-v_2-1)$, where $i = (k-v_1)/2-2$. In the second stage, let BP_2 be the path containing all vertices in the pol_1 ; and let $LD_2(0) = ((k-1, v_1+2), (k-1, v_1+1), (k-1, v_1), (k-2, v_1), (k-2, v_1+1), (k-2, v_1+2))$, $LD_2(1) = ((k-3, v_1+2), (k-3, v_1+1), (k-3, v_1), (k-4, v_1), (k-4, v_1+1), (k-4, v_1+2))$, \dots , $LD_2(j-1) = ((v_2+3, v_1+2), (v_2+3, v_1+1), (v_2+3, v_1), (v_2+2, v_1), (v_2+2, v_1+1), (v_2+2, v_1+2))$, $LD_2(j) = ((v_2+1, v_1+2),$

$(v_2+1, v_1+1), (v_2, v_1+1), (v_2, v_1+2)$), where $j = (k-v_2)/2-1$. Unify BP_2 with the above ladders, a $pl_2 = POL(BP_2, j+1, LD_2(0), LD_2(1), \dots, LD_2(j))$ can be derived; and there exists a residual vertex (v_2+1, v_1) adjacent to Y . As illustrated in Figure 7, the case that $(v_2, v_1) = (2, 4)$ of the $Tor(8, 8)$ is shown where the residual vertex is $(3, 4)$. By Proposition 8, there are paths joining X and Y of all even lengths ranging from $v_2R+v_1+2(i+1)(k-v_2)+2(k/2-2-i)(k-v_2-1)$ to k^2-2 where $i = (k-v_1)/2-2$. Combining the results of Lemma 1 and the above two stages, we know that there exist paths joining $X = (0, 0)$ and $Y = (v_2, v_1)$ of all even lengths ranging from v_2+v_1 to k^2-2 where v_2 and v_1 are both even numbers.

Case 2.2. v_2 and v_1 are odd numbers. By Lemma 1, we know that there exist paths joining $X = (0, 0)$ and $Y = (v_2, v_1)$ of all even lengths ranging from v_2+v_1 to v_2k+k-v_1-1 . Similar to Case 2.1, we can also prove that there exist paths joining $X = (0, 0)$ and $Y = (v_2, v_1)$ of all even lengths ranging from v_2+v_1 to k^2-2 where v_2 and v_1 are both odd numbers. Moreover, there exists a residual vertex (v_2, v_1-1) adjacent to Y in this case. Q. E. D.

Similar to the proof of Lemma 2, we can derive the following lemmas:

Lemma 3. For $X = (0, 0)$ and $Y = (v_2, v_1)$ of a $Tor(k, k)$ where k is odd and both of v_2 and v_1 are odd, there exist paths joining X and Y of all even lengths ranging from v_2+v_1 to k^2-1 .

Lemma 4. For $X = (0, 0)$ and $Y = (v_2, v_1)$ of a $Tor(k, k)$ where k is odd and both of v_2 and v_1 are even, there exist paths joining X and Y of all even lengths ranging from v_2+v_1 to k^2-1 .

Lemma 5. For $X = (0, 0)$ and $Y = (v_2, v_1)$ of a $Tor(k, k)$ where k is odd, one of v_1 and v_2 is odd, and the other is even, there exist paths joining X and Y of all odd lengths ranging from v_2+v_1 to k^2-2 . Moreover, there exists a residual vertex adjacent to Y .

By the symmetry of the $Tor(k, k)$, without loss of generality, we assume that v_1 is even and v_2 is odd. As illustrated in Figure 8 and Figure 9, the first stage and the second stage of the case that $Y = (3, 2)$ of the $Tor(9, 9)$ are shown, respectively. Moreover, there exists a residual vertex (v_2+1, v_1) adjacent to Y in this case.

Now, we study the paths joining two vertices in an odd $H(k, 2)$. Since the $H(k, 2)$ is a $Tor(k, k)$, without loss of generality, we assume that $X = (0, 0)$ and $Y = (v_2, v_1)$ of the $Tor(k, k)$ where $(k-1)/2 \geq v_2 \geq v_1 \geq 0$.

Lemma 6. There exist paths joining $X = (0, 0)$ and $Y = (v_2, v_1)$ of all lengths ranging from $k-v_2+v_1-1$ to k^2-1 in the odd $H(k, 2)$ where $(k-1)/2 \geq v_2 \geq v_1 \geq 0$.

Proof.

Case 1: Both of v_2 and v_1 are odd. By Lemma 3, we know that there exist paths joining $X = (0, 0)$ and $Y =$

(v_2, v_1) of all even lengths ranging from v_2+v_1 to k^2-1 in the odd $H(k, 2)$. By the symmetry of the odd $H(k, 2)$, there exists an automorphism to map each vertex (w_2, w_1) to the vertex $(k-w_2, w_1)$. Thus, Y can also be regarded as the vertex $(k-v_2, v_1)$. By Lemma 5, there exist paths of all odd lengths joining $X = (0, 0)$ and $Y = (v_2, v_1)$ ranging from $k-v_2+v_1$ to k^2-2 in the odd $H(k, 2)$. By definition, $(k-1)/2 \geq v_2 \geq v_1 \geq 0$; thus we know that $k-v_2+v_1 > v_2+v_1$. Consequently, there exist paths joining $X = (0, 0)$ and $Y = (v_2, v_1)$ of all lengths ranging from $k-v_2+v_1-1$ to k^2-1 in the odd $H(k, 2)$.

Case 2: Both of v_2 and v_1 are even. By Lemma 4, we know that there exist paths joining $X = (0, 0)$ and $Y = (v_2, v_1)$ of all even lengths ranging from v_2+v_1 to k^2-1 in the odd $H(k, 2)$. The remainder of the proof is similar to Case 1.

Case 3: v_2 is odd and v_1 is even. By Lemma 5, we know that there exist paths joining $X = (0, 0)$ and $Y = (v_2, v_1)$ of all odd lengths ranging from v_2+v_1 to k^2-2 in the odd $H(k, 2)$. By the symmetry of the odd $H(k, 2)$, there exists an automorphism to map each vertex (w_2, w_1) to the vertex $(k-w_2, w_1)$. Thus, Y can also be regarded as the vertex $(k-v_2, v_1)$. By Lemma 4, there exist paths joining $X = (0, 0)$ and $Y = (v_2, v_1)$ of all even lengths ranging from $k-v_2+v_1$ to k^2-1 in the odd $H(k, 2)$. By definition, $(k-1)/2 \geq v_2 \geq v_1 \geq 0$; thus we know that $k-v_2+v_1 > v_2+v_1$. Consequently, we know that there exist paths joining $X = (0, 0)$ and $Y = (v_2, v_1)$ of all lengths ranging from $k-v_2+v_1-1$ to k^2-1 in the odd $H(k, 2)$.

Case 4: v_2 is even and v_1 is odd. Similar to Case 3, we can prove that there exist paths joining $X = (0, 0)$ and $Y = (v_2, v_1)$ of all lengths ranging from $k-v_2+v_1-1$ to k^2-1 in the odd $H(k, 2)$. Q. E. D.

From the above lemma, clearly, the maximum value of $k-v_2+v_1-1$ is $k-1$ when $v_2 = v_1$. Thus, we have the following lemma.

Lemma 7. The odd $H(k, 2)$ is m -panconnected, where $m = k-1$.

Then, based on the above study on the $H(k, 2)$, we will investigate the path embedding properties of the $H(k, n)$. For that purpose, the following lemmas about $K(2) \times C(k)$ are required. As illustrated in Figure 10, the structure of $K(2) \times C(k)$ is shown.

Lemma 8. $K(2) \times C(k)$ is residual bipanconnected for k is even.

Proof. For the symmetry of the $K(2) \times C(k)$, without loss of generality, we assume that $X = (0, 0)$ and $Y = (v_2, v_1)$, where $0 \leq v_2 \leq 1, 0 \leq v_1 \leq k/2$.

Case 1: X and Y are in distinct partite sets. That is, v_2+v_1 is odd.

Subcase 1.1: $v_2 = 0$. Clearly, v_1 is an odd digit. In the first stage, let BP_1 be the shortest path joining X and Y , ($X = (0, 0), (0, 1), \dots, (0, v_1-1), (0, v_1) = Y$); and let $LD_1(0) = ((0, 0), (1, 0), (1, 1), (0, 1)), LD_1(1) = ((0, 2), (1, 2), (1, 3), (0, 3)), \dots, LD_1((v_1-1)/2) = ((0, v_1-1), (1,$

v_1-1), $(1, v_1)$, $(0, v_1)$). Unify BP_1 with the above ladders, a $pol_1 = POL(BP_1, (v_1+1)/2, LD(0), LD(1), \dots, LD((v_1-1)/2))$ can be derived. Thus, there exists a path joining X and Y of each odd length ranging from v_1 to $2v_1+1$. In the second stage, let BP_2 be the path containing all vertices in the pol_1 ; and let $LD_2(0) = ((1, v_1), (1, v_1+1), \dots, (1, k-1), (0, k-1), \dots, (0, v_1+1), (0, v_1))$. Unify BP_2 with $LD_2(0)$, a $pol_2 = POL(BP_1, 1, LD_2(0))$ can be derived. Thus, there exists a path of each odd length ranging from $2v_1+1$ to $2k-1$. Combining results of the two stages, we know that there exist a path joining $X = (0, 0)$ and $Y = (v_2, v_1)$ of each odd length ranging from v_1 to $2k-1$.

Subcase 1.2: $v_2 = 1$. Clearly, v_1 is an even digit. For $v_1 = 0$, by Proposition 1, there exists a path joining $(0, 0)$ and $(1, 0)$ of each odd length ranging from 1 to $2k-1$. Then, we consider the case that $v_1 \neq 0$. Similar to Subcase 1.1, we can prove that there exists a path joining X and Y of each odd length ranging from v_1+1 to $2k-1$, where $v_1+1 = Dist(X, Y)$.

Case 2: X and Y are in the same partite set. That is, v_2+v_1 is even.

Subcase 2.1: $v_2 = 0$. Clearly, v_1 is an even digit. In the first stage, let BP_1 be the shortest path joining X and Y , ($X = (0, 0)$, $(0, 1)$, \dots , $(0, v_1-1)$, $(0, v_1) = Y$); and let $LD_1(0) = ((0, 0), (1, 0), (1, 1), (0, 1))$, $LD_1(1) = ((0, 2), (1, 2), (1, 3), (0, 3))$, \dots , $LD_1((v_1-2)/2) = ((0, v_1-2), (1, v_1-2), (1, v_1-1), (0, v_1-1))$. Unify BP_1 with the above ladders, a $pol_1 = POL(BP_1, v_1/2, LD(0), LD(1), \dots, LD((v_1-2)/2))$ can be derived. Thus, there exists a path joining X and Y of each even length ranging from v_1 to $2v_1$; moreover, there exists a residual vertex $(0, v_1+1)$ adjacent to Y for these paths. In the second stage, let BP_2 be the path of length $2v_1$, ($X = (0, 0)$, $(1, 0)$, $(1, 1)$, $(0, 1)$, \dots , $(0, v_1-2)$, $(1, v_1-2)$, $(1, v_1-1)$, $(1, v_1)$, $(0, v_1) = Y$); and let $LD_2(0)$ be $((1, v_1), (1, v_1+1), \dots, (1, k-1), (0, k-1), \dots, (0, v_1+1), (0, v_1))$. Unify BP_2 with $LD_2(0)$, a $pol_2 = POL(BP_2, 1, LD_2(0))$ can be derived. Thus, there exists a path joining X and Y of each even length ranging from $2v_1$ to $2k-2$; moreover, there exists a residual vertex $(0, v_1-1)$ adjacent to Y for these paths. Combining results of the two stages, we know that there exist a path joining X and Y of each even length ranging from v_1 to $2k-2$; moreover, there exists a residual vertex adjacent to Y .

Subcase 2.2: $v_2 = 1$. Clearly, v_1 is an odd digit. Similar to Subcase 2.1, we can prove that there exists a path joining X and Y of each even length ranging from v_1+1 to $2k-2$; moreover, there exists a residual vertex $(1, v_1-1)$ adjacent to Y for these paths. Q. E. D.

4. Panconnected Properties of the $H(k, n)$

Then, we consider the paths joining arbitrary

two vertices of the $K(2) \times C(k)$ structure where k is odd. To simplify the proof, without loss of generality, we assume that $X = (0, 0)$ and $Y = (v_2, v_1)$, where $0 \leq v_2 \leq 1$, $0 \leq v_1 \leq (k-1)/2$.

Lemma 9. For two vertices $X = (0, 0)$ and $Y = (v_2, v_1)$ of $K(2) \times C(k)$ where k is odd,

- (1) if $Dist(X, Y)$ is odd, there exists a path of each odd length ranging from $Dist(X, Y)$ to $2k-1$ joining X and Y ; and there exists a path of each even length ranging from $Dist(X, Y)+k-2Min(k-v_1, v_1)$ to $2k-2$ joining X and Y that is adjacent to a residual vertex;
- (2) if $Dist(X, Y)$ is even, there exists a path of each even length ranging from $Dist(X, Y)$ to $2k-2$ joining X and Y that is adjacent to a residual vertex; and there exists a path of each odd length ranging from $Dist(X, Y)+k-2Min(k-v_1, v_1)$ to $2k-1$ joining X and Y .

Proof. Case 1: $Dist(X, Y)$ is odd.

Subcase 1.1: $v_2 = 0$ and v_1 is odd. (1) Similar to Subcase 1.1 of Lemma 8, there exists a path joining X and Y of each odd length ranging from $Dist(X, Y) = v_1$ to $2k-1$. (2) By the symmetry of the $K(2) \times C(k)$ structure, there exists an automorphism to map each vertex (w_2, w_1) to the vertex $(w_2, k-w_1)$. Thus, Y can also be regarded as the vertex $(v_2, k-v_1)$. Similar to Subcase 2.1 of Lemma 8, there exists a path joining X and Y of each even length ranging from $k-v_1$ to $2k-2$, where $k-v_1 = Dist(X, Y)+k-2Min(k-v_1, v_1)$ since $k-v_1 > v_1$ by the hypothesis that $v_1 \leq (k-1)/2$; moreover, there exists a residual vertex adjacent to Y .

Subcase 1.2: $v_2 = 1$ and v_1 is even. (1) Similar to Subcase 1.2 of Lemma 8, there exists a path joining X and Y of each odd length ranging from $Dist(X, Y) = 1+v_1$ to $2k-1$. (2) Similar to Subcase 2.2 of Lemma 8, there exists a path joining X and Y of each even length ranging from $k-v_1+1$ to $2k-2$, where $k-v_1+1 = Dist(X, Y)+k-2Min(k-v_1, v_1)$; moreover, there exists a residual vertex adjacent to Y .

Case 2: $Dist(X, Y)$ is even.

Subcase 2.1: $v_2 = 0$ and v_1 is even. (1) Similar to Subcase 2.1 of Lemma 8, there exists a path joining X and Y of each even length ranging from $Dist(X, Y) = v_1$ to $2k-2$; moreover, there exists a residual vertex adjacent to Y . (2) Similar to Subcase 1.1 of Lemma 8, there exists a path joining X and Y of each odd length ranging from $k-v_1$ to $2k-1$, where $k-v_1 = Dist(X, Y)+k-2Min(k-v_1, v_1)$.

Subcase 2.2: $v_2 = 1$ and v_1 is odd. (1) Similar to Subcase 2.2 of Lemma 8, there exists a path joining X and Y of each even length ranging from $Dist(X, Y) = 1+v_1$ to $2k-2$; moreover, there exists a residual vertex adjacent to Y . (2) Similar to Subcase 1.2 of Lemma 8, there exists a path joining X and Y of each odd length ranging from $k-v_1+1$ to $2k-1$, where $k-v_1+1 = Dist(X, Y)+k-2Min(k-v_1, v_1)$. Q. E. D.

Theorem 10. That is, even $H(k, n)$ is residual bipanconnected.

Proof. We will prove the lemma by induction on n .

For $n = 2$, By Lemma 2, the lemma holds.

Hypothesis: The lemma is true for $n = J \geq 2$.

Induction Step: By the symmetric properties of the $H(k, n)$, without loss of generality, let $X = u_{J+1} u_J \dots u_2 u_1 = 00 \dots 00$; and let $Y = v_{J+1} v_J \dots v_2 v_1$ be a vertex in an $H(k, J+1)$, where $0 \leq v_i \leq k/2$ for each $1 \leq i \leq J+1$; and $v_{J+1} \leq v_J \leq \dots \leq v_2 \leq v_1$.

Case 1: X and Y are in the distinct bipartite sets. That is, Y is an odd vertex.

Subcase 1.1: $v_{J+1} v_J \dots v_2$ is an odd vertex of the $OG(H(k, J+1))$. Clearly, v_1 is an even digit. Recall that the $OG(H(k, J+1))$ is an $H(k, J)$. By hypothesis, there exists a path of each odd length l ranging from $Dist(0^J, v_{J+1} v_J \dots v_2)$ to $k^J - 1$ joining $u_{J+1} u_J \dots u_2^* = 0^{J*}$ and $v_{J+1} v_J \dots v_2^*$, ($u_{J+1} u_J \dots u_2^* = 0^{J*} = V_0^*, V_1^*, V_2^*, \dots, V_l^* = v_{J+1} v_J \dots v_2^*$) in the $OG(H(k, J+1))$. Clearly, the path of odd length $Dist(0^J, v_{J+1} v_J \dots v_2) + v_1$, ($V_0 0, V_1 0, V_2 0, \dots, V_{l-1} 0, V_l 0, V_l 1, \dots, V_l(v_1 - 1), V_l v_1 = Y$), is the shortest path joining X and Y . Let BP be $(V_0 0, V_1 0, V_2 0, \dots, V_{l-3} 0, V_{l-2} 0)$; and let $LD(0) = (V_0 0, V_0 1, \dots, V_0 k-1, V_1 k-1, \dots, V_1 1, V_1 0)$, $LD(1) = (V_2 0, V_2 1, \dots, V_2 k-1, V_3 k-1, \dots, V_3 1, V_3 0)$, \dots , $LD((l-3)/2) = (V_{l-3} 0, V_{l-3} 1, \dots, V_{l-3} k-1, V_{l-2} k-1, \dots, V_{l-2} 1, V_{l-2} 0)$. Unify BP with the above ladders, a $pol = POL(BP, (l-1)/2, LD(0), LD(1), \dots, LD((l-3)/2))$ can be derived. Thus, there exists a path joining $X = V_0 0 = 0^J$ and $V_{l-2} 0$ of each odd length ranging from $l-2$ to $(l-1)k-1$. From Lemma 8, we know that there exists a path joining $V_{l-1} 0$ and $V_l v_1 = Y$ of each odd length ranging from $v_1 + 1$ to $2k-1$. Since $V_{l-2} 0$ is adjacent to $V_{l-1} 0$, there exists a path of each odd length ranging from $l+v_1$ to $((l-1)k-1) + (2k-1) + 1 = (l+1)k-1$. As illustrated in Figure 11, the case that $v_1 = 2$ and $k = 6$ is shown. Since there exists a path of each odd length l ranging from $Dist(0^J, v_{J+1} v_J \dots v_2)$ to $k^J - 1$ joining $u_{J+1} u_J \dots u_2^* = 0^{J*}$ and $v_{J+1} v_J \dots v_2^*$ in the $OG(H(k, J+1))$, there exists a path joining X and Y of each odd length ranging from $Dist(0^J, v_{J+1} v_J \dots v_2) + v_1 = Dist(0^{J+1}, v_{J+1} v_J \dots v_2 v_1)$ to $(k^J - 1 + 1)k - 1 = k^{J+1} - 1$.

Subcase 1.2: $v_{J+1} v_J \dots v_2$ is an even vertex of the $OG(H(k, J+1))$ and $v_{J+1} v_J \dots v_2 \neq u_{J+1} u_J \dots u_2$. Similar to Subcase 1.1, it is not difficult to find that there exists a path joining X and Y of each odd length ranging from $Dist(0^J, v_{J+1} v_J \dots v_2) + v_1 = Dist(0^{J+1}, v_{J+1} v_J \dots v_2 v_1)$ to $k^{J+1} - 1$.

Subcase 1.3: $v_{J+1} v_J \dots v_2 = 00 \dots 0 = u_{J+1} u_J \dots u_2$. Since $v_{J+1} v_J \dots v_2 v_1$ is an odd vertex, v_1 must be an odd digit. By Proposition 2, there exists a Hamiltonian path, ($u_{J+1} u_J \dots u_2^* = v_{J+1} v_J \dots v_2^* = V_0^*, V_1^*, \dots, V_{N-2}^*, V_{N-1}^*$) of the $OG(H(k, J+1))$, where $N = k^J$. By Lemma 8, there exists a path joining X and Y of each odd length ranging from $v_1 = Dist(X, Y)$ to $2k-1$ in the $K(2) \times C(k)$ network, (V_0^*, V_1^*). Then, let BP be the path $(V_0 0, V_1 0, V_1 1, V_0 1, V_0 2, V_1 2, \dots, V_0(v_1 - 1), V_1$

$(v_1 - 1), V_1 v_1, V_1(v_1 + 1), \dots, V_1(k-1), V_0(k-1), \dots, V_0(v_1 + 1), V_0 v_1)$; and let $LD(0) = (V_1 0, V_2 0, \dots, V_{N-1} 0, V_{N-1} 1, \dots, V_2 1, V_1 1)$, $LD(1) = (V_1 2, V_2 2, \dots, V_{N-1} 2, V_{N-1} 3, \dots, V_2 3, V_1 3)$, \dots , $LD(k/2 - 1) = (V_1(k-2), V_2(k-2), \dots, V_{N-1}(k-1), V_{N-1}(k-1), \dots, V_2(k-1), V_1(k-1))$. Unify BP with $LD(0), LD(1), \dots, LD(k/2 - 1)$, a $pol = POL(BP, k/2, LD(0), LD(1), \dots, LD(k/2 - 1))$ can be derived. As illustrated in Figure 12, we show the pol for the case that $v_1 = 3$ of the $H(8, 2)$. Thus, there exists a path joining X and Y of each odd length ranging from $2k-1$ to $2k-1 + (k^J - 2)k = k^{J+1} - 1$. Combining the above results, we know that there exists a path joining X and Y of each odd length ranging from $v_1 = Dist(X, Y)$ to $k^{J+1} - 1$.

Case 2: X and Y are in the same bipartite set. That is, Y is an even vertex.

Subcase 2.1: $v_{J+1} v_J \dots v_2$ is an odd vertex of the $OG(H(k, J+1))$. Clearly, v_1 is an odd digit. By Lemma 8, similar to Subcase 1.1, we can prove that there exists a path joining X and Y of each even length ranging from $Dist(0^J, v_{J+1} v_J \dots v_2) + v_1 = Dist(0^{J+1}, v_{J+1} v_J \dots v_2 v_1)$ to $k^{J+1} - 2$. Moreover, there exists a residual vertex adjacent to Y .

Subcase 2.2: $v_{J+1} v_J \dots v_2$ is an even vertex of the $OG(H(k, J+1))$ and $v_{J+1} v_J \dots v_2 \neq u_{J+1} u_J \dots u_2$. Similar to Subcase 1.2, there exists a path joining X and Y of each even length ranging from $Dist(0^J, v_{J+1} v_J \dots v_2) + v_1 = Dist(0^{J+1}, v_{J+1} v_J \dots v_2 v_1)$ to $k^{J+1} - 2$. Moreover, there exists a residual vertex adjacent to Y .

Subcase 2.3: $v_{J+1} v_J \dots v_2 = 00 \dots 0 = u_{J+1} u_J \dots u_2$. By Lemma 8, similar to Subcase 1.3, we can prove that there exists a path joining X and Y of each even length ranging from $v_1 = Dist(X, Y)$ to $k^{J+1} - 2$. Moreover, there exists a residual vertex adjacent to Y . This extends the induction and completes the proof. Q. E. D.

Lemma 11. For arbitrary two vertices X and Y of an odd $H(k, n)$,

- (1) there exists a path of each odd length ranging from $ODist(X, Y)$ to $k^n - 2$ joining X and Y that is adjacent to a residual vertex;
- (2) there exists a path of each even length ranging from $EDist(X, Y)$ to $k^n - 1$ joining X and Y .

Proof. We will prove the lemma by induction on n .

For $n = 2$, the lemma holds by Lemma 3, 4 and 5.

Hypothesis: The lemma is true for $n = J \geq 2$.

Induction Step: By the symmetric properties of the $H(k, n)$, without loss of generality, let $X = u_{J+1} u_J \dots u_2 u_1 = 00 \dots 00$; and let $Y = v_{J+1} v_J \dots v_2 v_1$ be a vertex in an $H(k, J+1)$, where $0 \leq v_i \leq (k-1)/2$ for each $1 \leq i \leq J+1$; and $v_{J+1} \leq v_J \leq \dots \leq v_2 \leq v_1$.

Case 1: v_1 is an odd digit.

Recall that the $OG(H(k, J+1))$ is an $H(k, J)$. By hypothesis, there exists a path of each odd length l

ranging from $ODist(0^J, v_{J+1} v_J \dots v_2)$ to k^J-2 joining $u_{J+1} u_J \dots u_2^* = 0^{J^*}$ and $v_{J+1} v_J \dots v_2^*$, ($u_{J+1} u_J \dots u_2^* = 0^{J^*} = V_0^*, V_1^*, V_2^*, \dots, V_l^* = v_{J+1} v_J \dots v_2^*$) in the $OG(H(k, J+1))$. Since l ranges from $ODist(0^J, v_{J+1} v_J \dots v_2)$ to k^J-2 , similar to Subcase 2.1 of Theorem 10, by Lemma 9, we can prove that there exists a path of each even length ranging from $ODist(0^J, v_{J+1} v_J \dots v_2)+v_1$ to $(k^J-2)k-1 = k^{J+1}-2k-1$ joining $X = V_0 0$ and $Y = V_l v_1$. By hypothesis, there exists a residual vertex V_{l+1}^* for the path of odd length l joining $V_0^* = 0^{J^*}$ and $V_l^* = v_{J+1} v_J \dots v_2^*$ in the $OG(H(k, n))$ for k is odd. Consider the path $(0^{J^*} = V_0^*, V_1^*, V_2^*, \dots, V_{N-2}^* = v_{J+1} v_J \dots v_2^*, V_{N-1}^*)$ where $N = k^J$. Let P_0 be $(V_0 0, V_0 1, \dots, V_0 k-2, V_0 k-1, V_1 k-1, V_1 k-2, \dots, V_1 1, V_1 0, \dots, V_{N-5} 0, V_{N-5} 1, \dots, V_{N-3} 0, V_{N-3} 1, \dots, V_{N-3} k-2, V_{N-3} k-1)$. By Lemma 9, there exists a path P_1 of each odd length ranging from $k-1-v_1$ to $2k-1$ joining $V_{N-2} k-1$ and $V_{N-2} v_1 = Y$. Concatenating P_0 and P_1 , a path of each even length ranging from $((k^J-2)k-1)+1+(k-1-v_1) = k^{J+1}-k-1-v_1$ to $k^{J+1}-1$ joining X and Y can be derived. Combining the above results, we know that there exists a path of each even length ranging from $ODist(0^J, v_{J+1} v_J \dots v_2)+v_1$ to $k^{J+1}-1$ joining X and Y . Likewise, we can derive that there exists a path of each odd length ranging from $EDist(0^J, v_{J+1} v_J \dots v_2)+v_1$ to $k^{J+1}-2$ joining X and Y ; moreover, Y is adjacent to a residual vertex. By the symmetric properties, $v_{J+1} v_J \dots v_2 v_1$ can be regarded as $v_{J+1} v_J \dots v_2 (k-v_1)$. Clearly, $k-v_1$ is an even digit. Likewise, we can prove that there exists a path of each odd length ranging from $ODist(0^J, v_{J+1} v_J \dots v_2)+(k-v_1)$ to $k^{J+1}-2$ joining X and Y that is adjacent to a residual vertex; and there exists a path of each even length ranging from $EDist(0^J, v_{J+1} v_J \dots v_2)+(k-v_1)$ to $k^{J+1}-1$ joining X and Y . Clearly, $EDist(0^{J+1}, v_{J+1} v_J \dots v_2 v_1) = \text{Min}(ODist(0^J, v_{J+1} v_J \dots v_2)+v_1, EDist(0^J, v_{J+1} v_J \dots v_2)+(k-v_1))$; thus, there exists a path of each even length ranging from $EDist(0^{J+1}, v_{J+1} v_J \dots v_2 v_1)$ to $k^{J+1}-1$ joining X and Y . Likewise, $ODist(0^{J+1}, v_{J+1} v_J \dots v_2 v_1) = \text{Min}(EDist(0^J, v_{J+1} v_J \dots v_2)+v_1, ODist(0^J, v_{J+1} v_J \dots v_2)+(k-v_1))$, thus, there exists a path of each odd length ranging from $ODist(0^{J+1}, v_{J+1} v_J \dots v_2 v_1)$ to $k^{J+1}-2$ joining X and Y ; moreover, Y is adjacent to a residual vertex.

Case 2: v_1 is an even digit. The proof is similar to Case 1. Q. E. D.

By the above lemma, we have

Corollary 12. For two vertices of the $H(k, n)$, there exists a path joining X and Y of each length ranging from $ODist(X, Y)-1$ (Respectively, $EDist(X, Y)-1$) for $ODist(X, Y) > EDist(X, Y)$ (Respectively, $EDist(X, Y) > ODist(X, Y)$) to k^l-1 .

Theorem 13. The odd $H(k, n)$ is strictly m -panconnected, where $m = n(k-1)/2$.

Proof. Without loss of generality, let $X = u_n u_{n-1} \dots u_2 u_1 = 00 \dots 00$; and let $Y = v_n v_{n-1} \dots v_2 v_1$ be a vertex in the $H(k, n)$, where $0 \leq v_i \leq (k-1)/2$ for each $1 \leq i \leq n$; and $v_n \leq v_{n-1} \leq \dots \leq v_2 \leq v_1$. Clearly, $Dist(X, Y) \leq nv_1$;

thus, by Proposition 6, for $Dist(X, Y) = ODist(X, Y)$ (Respectively, $Dist(X, Y) = EDist(X, Y)$), the $EDist(X, Y)$ (Respectively, $ODist(X, Y)$) $\leq nv_1+k-2v_1 \leq n(k-1)/2+k-2(k-1)/2 = n(k-1)/2+1$. By Corollary 12, we know that there exists a path joining X and Y of each length ranging from $n(k-1)/2$ to k^n-1 . Moreover, $n(k-1)/2$ is the diameter of the odd $H(k, n)$, it has reached the lower bound of this problem. Q. E. D.

5. The Pancyclic Properties

Theorem 14. The even $H(k, n)$ is bipancyclic for $n \geq 2$.

Proof. In the first stage, owing to that the $OG(H(k, n))$ is a $H(k, n-1)$ and that the $H(k, n-1)$ is Hamiltonian, there exists a $P(N-1) \times C(k)$, $(V_0^*, V_1^*, \dots, V_{N-3}^*, V_{N-2}^*, V_{N-1}^*)$, where $N = k^{n-1}$. Clearly, $P(N-1) \times K(2)$ that is an $L(N-1)$ is a subgraph of the $P(N-1) \times C(k)$. From Proposition 1, the $H(k, n)$ contains cycles of each even length ranging from 4 to $2N$. In the second stage, we show that the $H(k, n)$ can embed a cycle-of-ladders as a subgraph. Let BC be $(V_0 0, V_0 1, \dots, V_0 k-1)$, and let $LD(0) = \{V_0 0, V_1 0, \dots, V_{N-2} 0, V_{N-1} 0, V_{N-1} 1, V_{N-2} 1, \dots, V_1 1, V_0 1\}$, $LD(1) = \{V_0 2, V_1 2, \dots, V_{N-2} 2, V_{N-1} 2, V_{N-1} 3, V_{N-2} 3, \dots, V_1 3, V_0 3\}$, \dots , $LD((k-1)/2-1) = \{V_0 k-3, V_1 k-3, \dots, V_{N-2} k-3, V_{N-1} k-3, V_{N-1} k-2, V_{N-2} k-2, \dots, V_1 k-2, V_0 k-2\}$. Unify BC with the above ladders, a $COL(BC, k/2, LD(0), LD(1), \dots, LD(k/2-1))$ can be derived. As illustrated in Figure 13, the structure of the cycle-of-ladders embedded in the $H(5, 2)$ is shown. By Proposition 9, we know that the even $H(k, n)$ contains a cycle of each even length ranging from k to $k+(2N-2)k/2 = Nk = n^k$. Combining the above results, we know that the even $H(k, n)$ contains a cycle of each even length ranging from 4 to k^n for $n \geq 2$. Q. E. D.

Lemma 15. The odd $H(k, n)$ embeds a cycle of each even length ranging from 4 to k^n-1 for $n \geq 2$.

Proof. In the first stage, owing to that the $OG(H(k, n))$ is a $H(k, n-1)$ and that the $H(k, n-1)$ is Hamiltonian, there exists a $P(N-1) \times C(k)$, $(V_0^*, V_1^*, \dots, V_{N-3}^*, V_{N-2}^*, V_{N-1}^*)$, where $N = k^{n-1}$. Clearly, $P(N-1) \times K(2)$ that is an $L(N-1)$ is a subgraph of the $P(N-1) \times C(k)$. From Proposition 1, the $H(k, n)$ contains cycles of each even length ranging from 4 to $2N$. In the second stage, we show that the $H(k, n)$ can embed a cycle-of-ladders as a subgraph. Let the bone cycle BC_1 be $(V_0 1, V_1 1, \dots, V_{N-2} 1, V_{N-1} 1, V_{N-1} 0, V_{N-2} 0, \dots, V_1 0, V_0 0)$. And let the i th ladder $LD_1(i)$ be $\{V_{2i} 1, V_{2i} 2, \dots, V_{2i} k-2, V_{2i} k-1, V_{2i+1} k-1, V_{2i+1} k-2, \dots, V_{2i+1} 2, V_{2i+1} 1\}$ with the edge $(V_{2i} 1, V_{2i+1} 1)$ as the bottom rung for each i where $0 \leq i \leq (N-1)/2-1$. Unify BC_1 with the above ladders, a $col_1 = COL(BC_1, (N-1)/2, LD_1(0), LD_1(1), \dots, LD_1((N-1)/2-1))$ can be derived. By Proposition 9, we know that the odd $H(k, n)$ contains a cycle of each even length ranging from $2N$ to $2N+(2k-4) \times (N-1)/2 = kN-k+2$ for $n \geq 2$. In the third

stage, let BC_2 be the path containing all vertices in the col_1 , and let $LD_2(0) = \{V_{N-2} 2, V_{N-1} 2, V_{N-1} 3, V_{N-2} 3\}$, $LD_2(1) = \{V_{N-2} 4, V_{N-1} 4, V_{N-1} 5, V_{N-2} 5\}$, ..., $LD_2((k-3)/2-1) = \{V_{N-2} k-3, V_{N-1} k-3, V_{N-1} k-2, V_{N-2} k-2\}$. Unify BC_2 with the above ladders, a $col_2 = COL(BC_2, (k-3)/2, LD_1(0), LD_1(1), \dots, LD_1((k-3)/2-1))$ can be derived. As illustrated in Figure 14, the structure of the col_2 embedded in the $H(9, 2)$ is shown. Thus, we know that the odd $H(k, n)$ contains a cycle of each even length ranging from $kN-k+2$ to $kN-k+2+(k-3) = kN-1 = k^n-1$. Combining the above results, we know that the odd $H(k, n)$ contains a cycle of each even length ranging from 4 to k^n-1 . Q. E. D.

Lemma 16. The odd $H(k, n)$ embeds a cycle of each odd length ranging from k to k^n for $n \geq 2$.

Proof. In the first stage, owing to that the $OG(H(k, n))$ is a $H(k, n-1)$ and that the $H(k, n-1)$ is Hamiltonian, there exists a $P(N-1) \times C(k)$, $(V_0^*, V_1^*, \dots, V_{N-3}^*, V_{N-2}^*, V_{N-1}^*)$, where $N = k^{n-1}$. Let BC_1 be $(V_0 0, V_0 1, \dots, V_0 k-1)$, and let $LD_1(0) = \{V_0 0, V_1 0, \dots, V_{N-2} 0, V_{N-1} 0, V_{N-1} 1, V_{N-2} 1, \dots, V_1 1, V_0 1\}$, $LD_1(1) = \{V_0 2, V_1 2, \dots, V_{N-2} 2, V_{N-1} 2, V_{N-1} 3, V_{N-2} 3, \dots, V_1 3, V_0 3\}$, ..., $LD_1((k-1)/2-1) = \{V_0 k-3, V_1 k-3, \dots, V_{N-2} k-3, V_{N-1} k-3, V_{N-1} k-2, V_{N-2} k-2, \dots, V_1 k-2, V_0 k-2\}$. Unify BC_1 with the above ladders, a $col_1 = COL(BC_1, (k-1)/2, LD_1(0), LD_1(1), \dots, LD_1((k-1)/2-1))$ can be derived. By Proposition 9, we know that the odd $H(k, n)$ contains a cycle of each odd length ranging from k to $k+(2N-2)(k-1)/2 = Nk-N+1$. In the second stage, let BC_2 be the cycle containing all vertices in the col_1 ; and let $LD_2(0) = \{V_1 k-2, V_2 k-2, V_2 k-1, V_1 k-1\}$, $LD_2(1) = \{V_3 k-2, V_4 k-2, V_4 k-1, V_3 k-1\}$, ..., $LD_2((N-1)/2-1) = \{V_{N-2} k-2, V_{N-1} k-2, V_{N-1} k-1, V_{N-2} k-1\}$. Unify BC_2 with the above ladders, a $col_2 = COL(BC_2, (N-1)/2, LD_2(0), LD_2(1), \dots, LD_2((N-1)/2-1))$ can be derived. As illustrated in Figure 15, the structure of the col_2 embedded in the $H(5, 2)$ is shown. By Proposition 9, we know that the odd $H(k, n)$ contains a cycle of each odd length ranging from $Nk-N+1$ to $(Nk-N+1)+(N-1) = Nk = k^n$ for $n \geq 2$. Combining the above results, we know that the odd $H(k, n)$ contains a cycle of each odd length ranging from k to k^n for $n \geq 2$. Q. E. D.

Combining Lemma 15 and Lemma 16, we have

Lemma 17. For $n \geq 2$, the odd $H(k, n)$ is m -pancyclic; where $m = k-1$ for $k \geq 5$, and $m = 3$ for $k = 3$.

Lemma 18. The length of the smallest odd cycle in the odd $H(k, n)$ is k .

Proof. Suppose that there exists a cycle of odd length r , $r < k$, in the odd $H(k, n)$. Let $X = v_n v_{n-1} \dots v_2 v_1$ be a vertex contained in the cycle. Along the cycle from X to X , a sequence of r transitions can be derived. Since $r < k$, it's impossible that there exist k $i+$ transitions or k $i-$ transitions for each $1 \leq i \leq n$ in the sequence. There are the same number of $i+$ transitions and $i-$ transitions for each $1 \leq i \leq n$ in the sequence. Thus, the sequence has even transitions, a contradiction.

Q. E. D.

From Lemma 17 and Lemma 18, we have

Lemma 19. The odd $H(k, n)$ is pancyclic for $k = 3$.

Theorem 20. The odd $H(k, n)$ is strictly $(k-1)$ -pancyclic for $k \geq 5$.

6. Conclusions

In this paper, we study the panconnected properties and the pancyclic properties of the k -ary n -cubes. We show that the k -ary n -cube is residual bipanconnected for k is even and $n \geq 2$. The k -ary n -cube is also shown to be strictly m -panconnected where m is $(k-1)n/2$ for k is odd and $n \geq 2$. We show that the even k -ary n -cube is bipancyclic for $n \geq 2$. The odd k -ary n -cube is shown to be strictly m -pancyclic where $m = k-1$, $k \geq 5$ and $n \geq 2$. That is, it embeds all cycles of lengths ranging from $k-1$ to N ; and $k-1$ has reached the lower bound of this problem. Furthermore, owing to that the k -ary n -cube is vertex transitive and edge transitive, the even k -ary n -cube is vertex-bipancyclic and edge-bipancyclic for $n \geq 2$; whereas, the odd k -ary n -cube is strictly m -vertex-pancyclic and m -edge-pancyclic where $m = k-1$, for $k \geq 5$ and $n \geq 2$. The work will help the engineers to develop corresponding application on the multiprocessor systems that employ the k -ary n -cubes as the interconnection networks. It will also help a further investigation on the k -ary n -cubes. For example, to find a fault tolerant algorithm to generate the bipanconnected paths and m -panconnected paths on the k -ary n -cubes appears interesting.

Acknowledgments

This work was supported in part by the National Science Council of the Republic of China under the contract number: NSC95-2221-E-142-003.

REFERENCE

- [1] Ametek Corporation, Ametek Series 2010 Brochures.
- [2] T. Araki and Y. Shibata, "Pancyclicity of recursive circulant graphs", Information Processing Letters, 81(4), pp.187-190, 2002.
- [3] Y. Ashir, I. A. Stewart and A. Ahmed, "Communication algorithms in k -ary n -cube interconnection networks", Information Processing Letters, 61(1), pp.43-48, 1997.
- [4] B. Bose, B. Broeg, Y. Kwon, and Y. Ashir, "Lee distance and topological properties of k -Ary n -Cubes", IEEE Trans. Computers, pp.1021-1030, 1995.

- [5] J. M. Chang, J. S. Yang, Y. L. Wang and Y. Cheng, "Panconnectivity, fault-tolerant hamiltonicity and hamiltonian-connectivity in alternating group graphs", *Networks*, 44(4), pp.302-310, 2004.
- [6] K. S. Hu, S. S. Yeoh, C. Chen and L. H. Hsu, "Node-pancyclicity and edge-pancyclicity of hypercube variants", *Information Processing Letters*, 102(1), pp.1-7, 2007.
- [7] S. Lakshminarayanan and S. K. Dhall, "Ring, torus and hypercube architectures/algorithms for parallel computing", *Parallel Computing*, 25, pp.1877-1906, 1999.
- [8] F. T. Leighton, "Introduction to Parallel Algorithms and Architectures: Arrays, Trees, Hypercubes", Morgan Kaufmann, California, 1992.
- [9] T. K. Li, C. H. Tsai, J. J. M. Tan and L. H. Hsu, "Bipanconnectivity and edge-fault-tolerant bipancyclicity of hypercubes", *Information Processing Letters*, 87, pp.107-110, 2003.
- [10] Y. C. Lin, "On balancing sorting on a linear array", *IEEE Transactions on Parallel and Distributed Systems*, 4(5), pp.566-571, 1993.
- [11] NCUBE Corporation, "NCUBE Handbook", Beaverton, Ore., 1986.
- [12] W. Oed, "Massively Parallel Processor System CRAY T3D", technical report, Cray Research GmbH, 1993.
- [13] B. Ucar, C. Aykanat, K. Kaya and M. Ikinici, "Task assignment in heterogeneous computing systems", *Journal of Parallel and Distributed Computing*, 66(1), pp.32-46, 2006.
- [14] Tera Computer Systems, "Overview of the Tera Parallel Computer", 1993.
- [15] D. Wang, T. An, M. Pan, K. Wang and S. Qu, "Hamiltonian-like properties of k -ary n -cubes, in Proceedings of International Conference on Parallel and Distributed Computing", Applications and Technologies, pp.1002-1007, 2005.
- [16] M. C. Yang, J. J. M. Tan and L. H. Hsu, "Hamiltonian circuit and linear array embeddings in faulty k -ary n -cubes", *Journal of Parallel and Distributed Computing*, 67(4), pp.362-368, 2007.

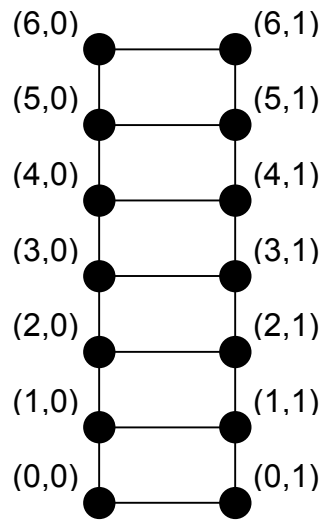

Figure 1. The structure of an $L(6)$.

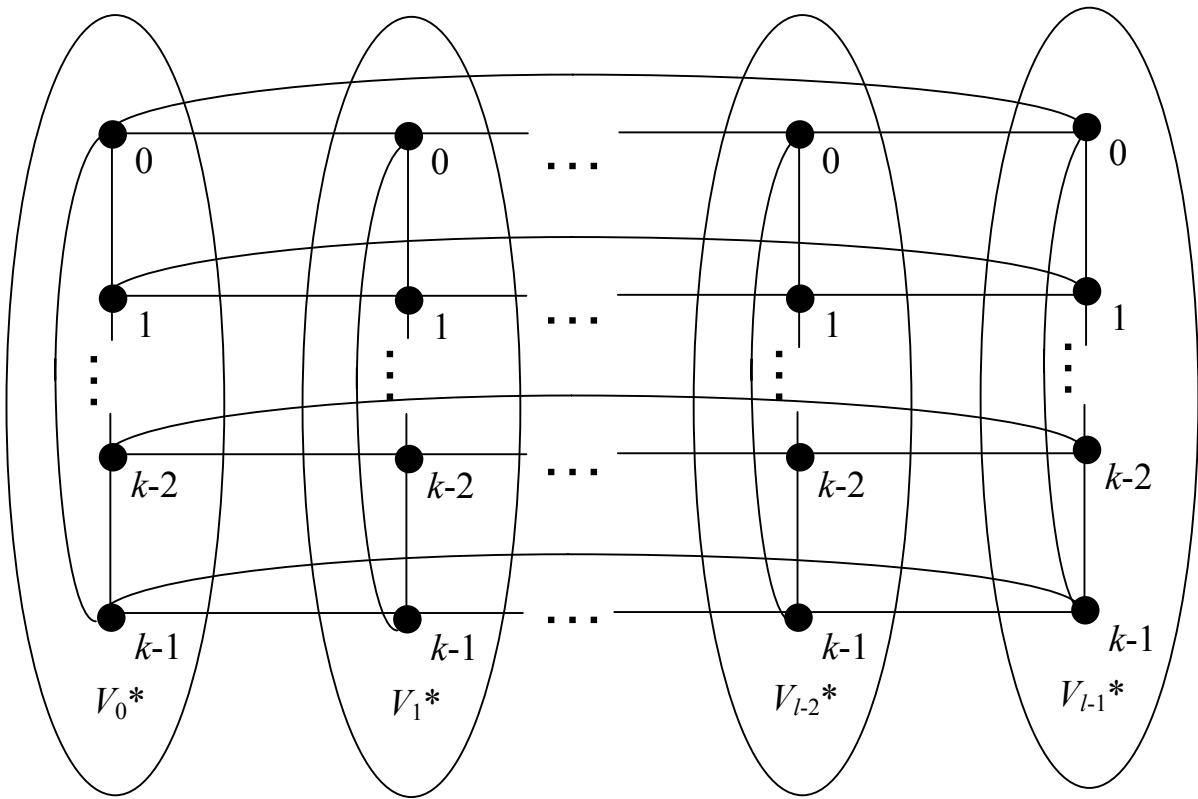

Figure 2. Embedding the structure of $C(l) \times C(k)$ in $H(k, n)$ if $C(l)$ is embedded in $OG(H(k, n))$.

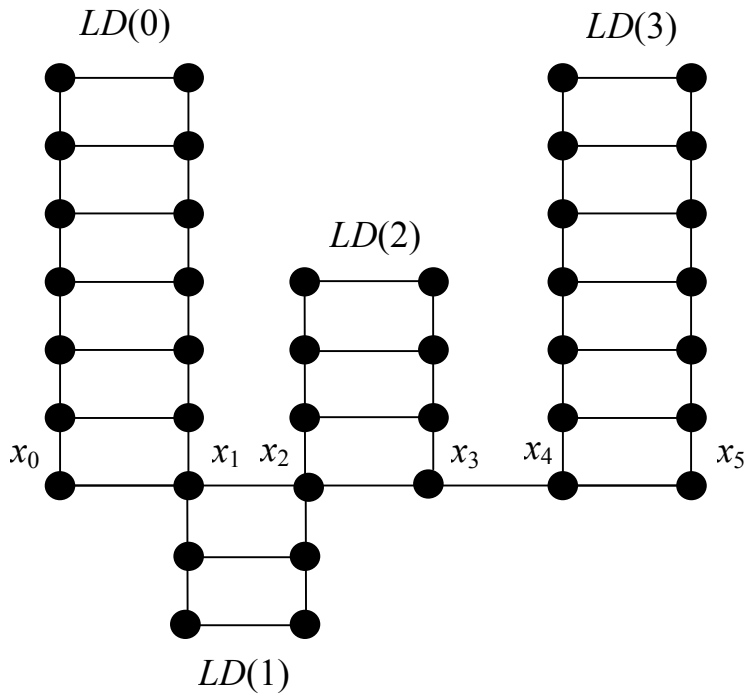

Figure 3. The structure of a path-of-ladders graph.

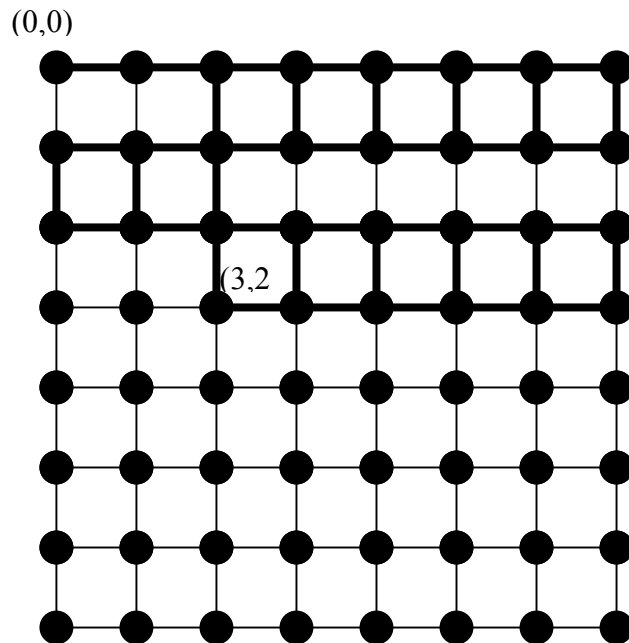

Figure 4. Embedding the paths of odd length ranging from 5 to 29 joining $(0, 0)$ and $(3, 2)$ of the $Tor(8, 8)$, where the wraparound edges are omitted.

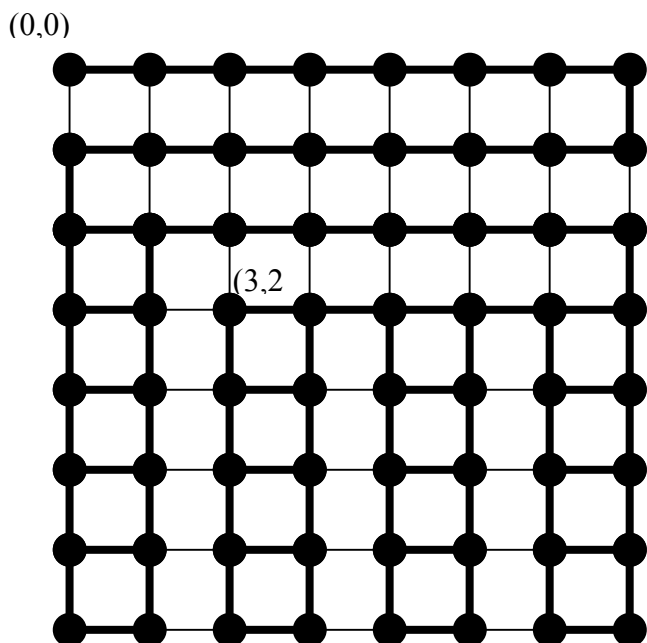

Figure 5. Generating the path of ladders for $(3, 2)$ of the $Tor(8, 8)$.

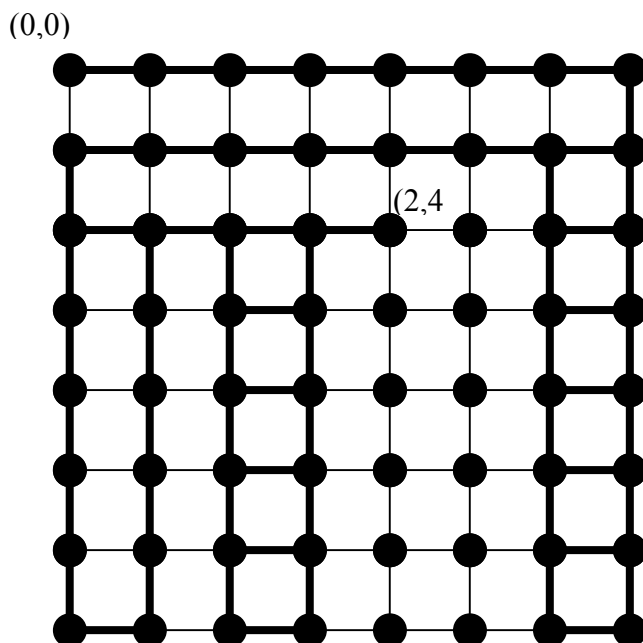

Figure 6. Generating the paths of ladders for $(2, 4)$ of the $Tor(8, 8)$ in the first stage.

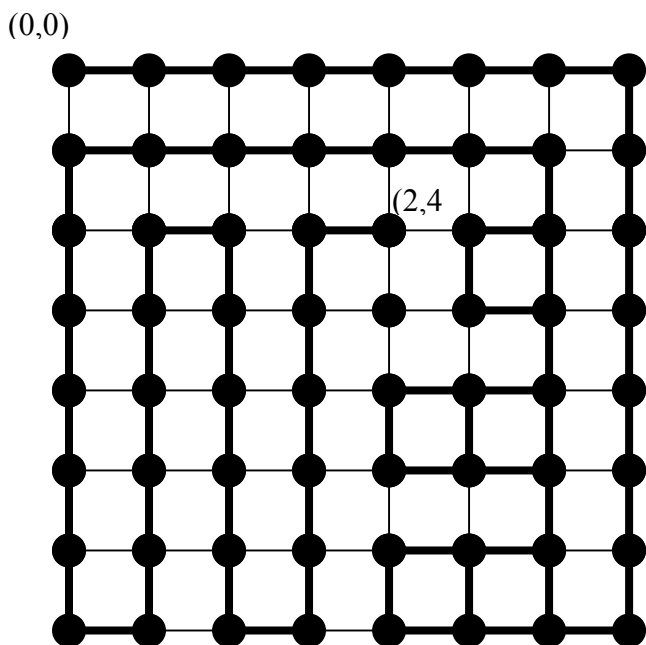

Figure 7. Generating the paths of ladders for $(2, 4)$ of the $Tor(8, 8)$ in the second stage.

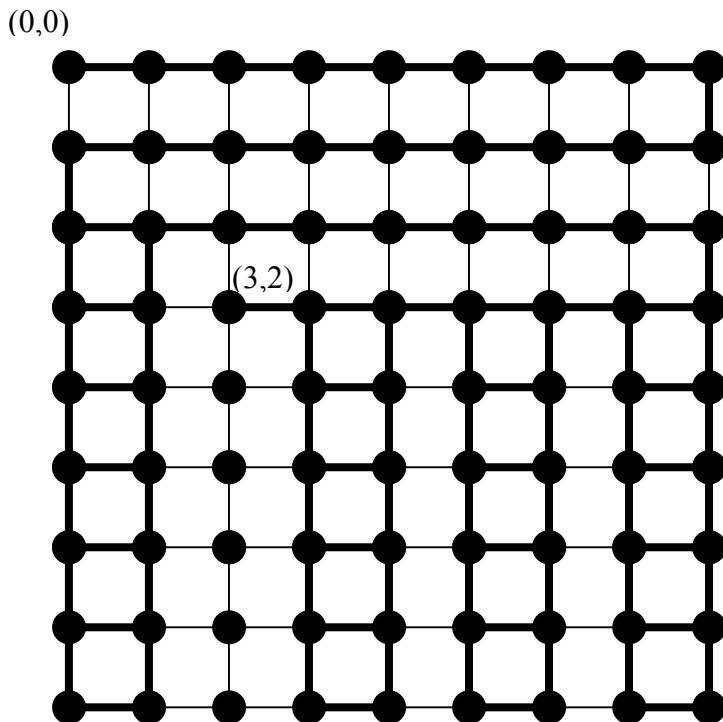

Figure 8. Generating the paths of ladders for $(3, 2)$ of the $Tor(9, 9)$ in the first stage.

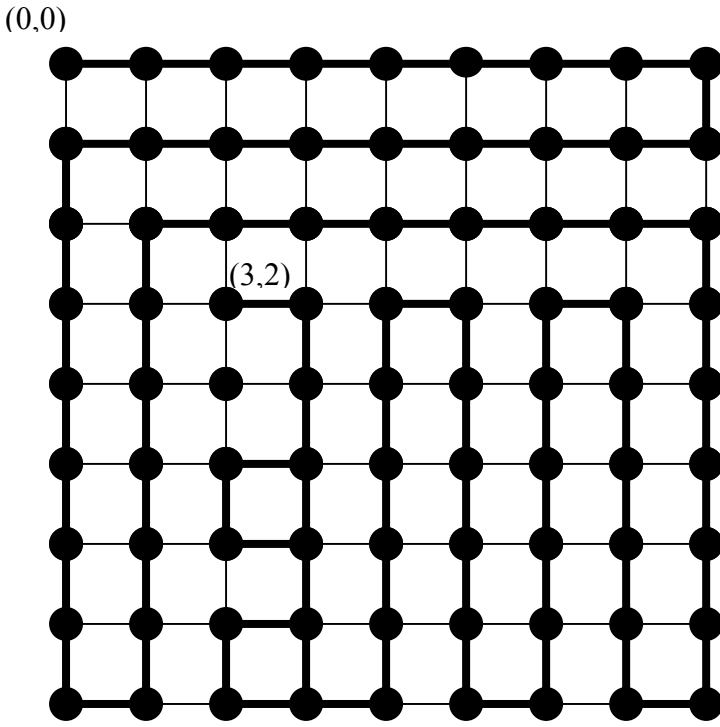

Figure 9. Generating the paths of ladders for $(3, 2)$ of the $Tor(9, 9)$ in the second stage.

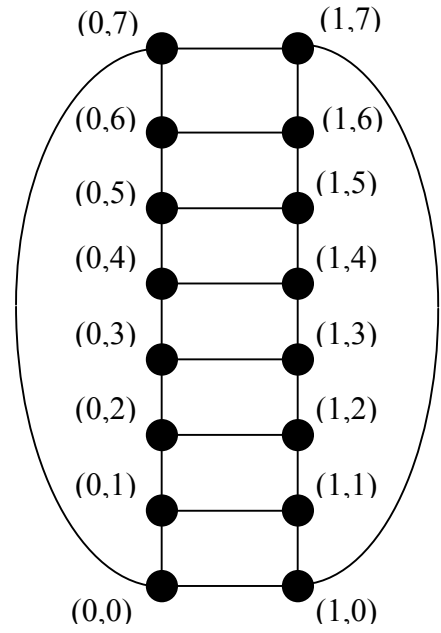

Figure 10. The structure of the $K(2) \times C(8)$ structure.

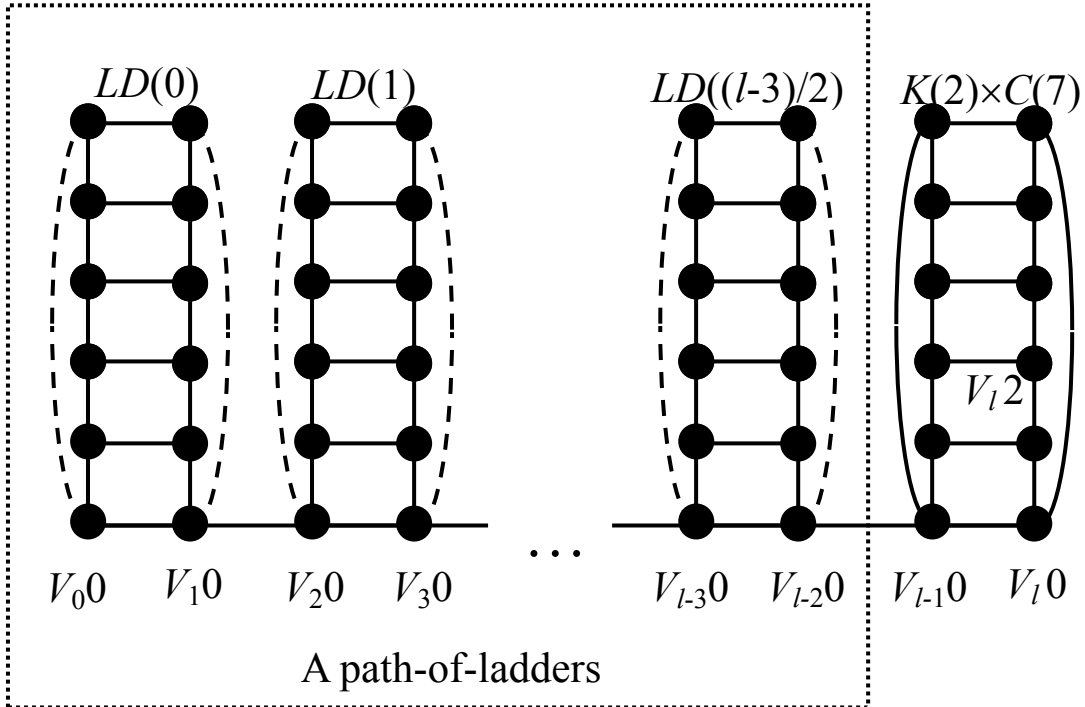

Figure 11. Finding the path joining V_{00} and V_{l2} of each odd length ranging from $l+2$ to $(l+1)k-1$, where l is even.

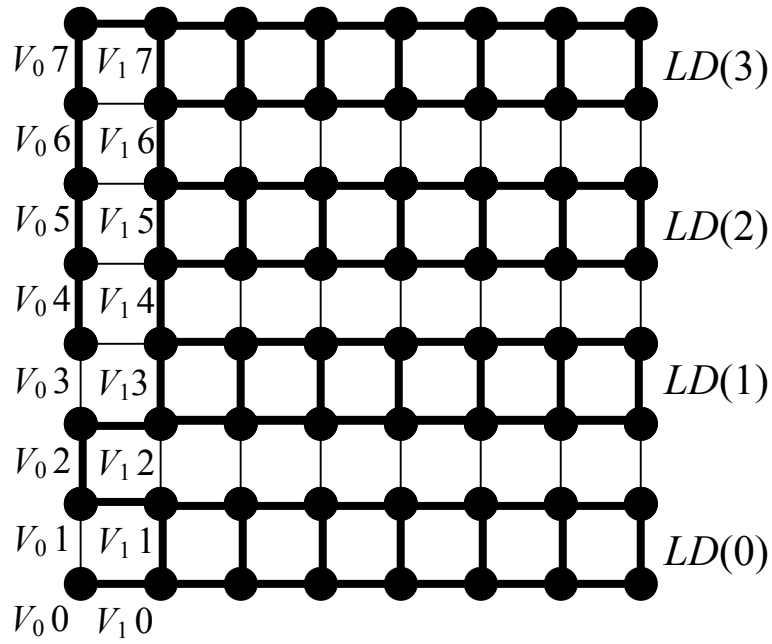

Figure 12. In the even $H(k, n)$, finding the path joining $V_0 0$ and $V_0 3$ of each odd length ranging from $2k-1$ to $Nk-1$, where N is k^{n-1} .

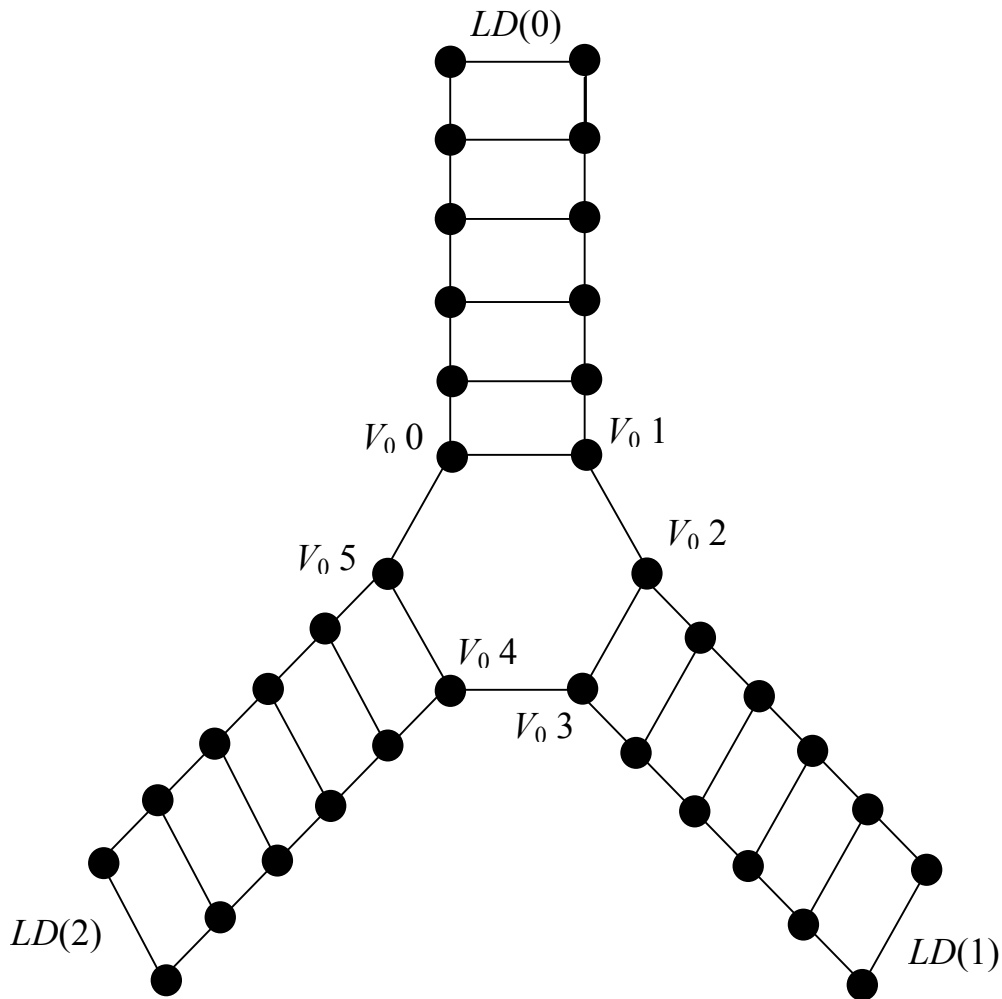

Figure 13. Embedding the cycle-of-ladders to the $H(6, 2)$.

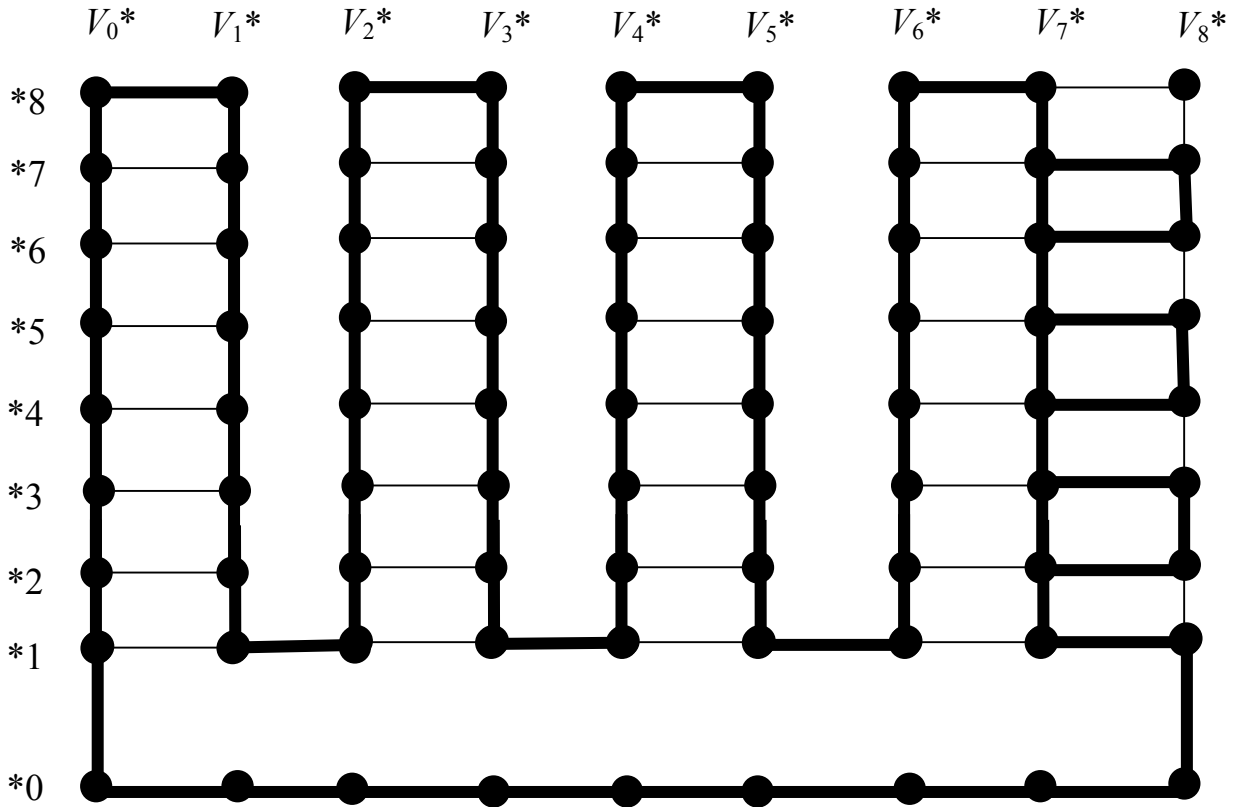

Figure 14. Embedding the cycle of ladders drawn by the bold lines into the $H(9, 2)$.

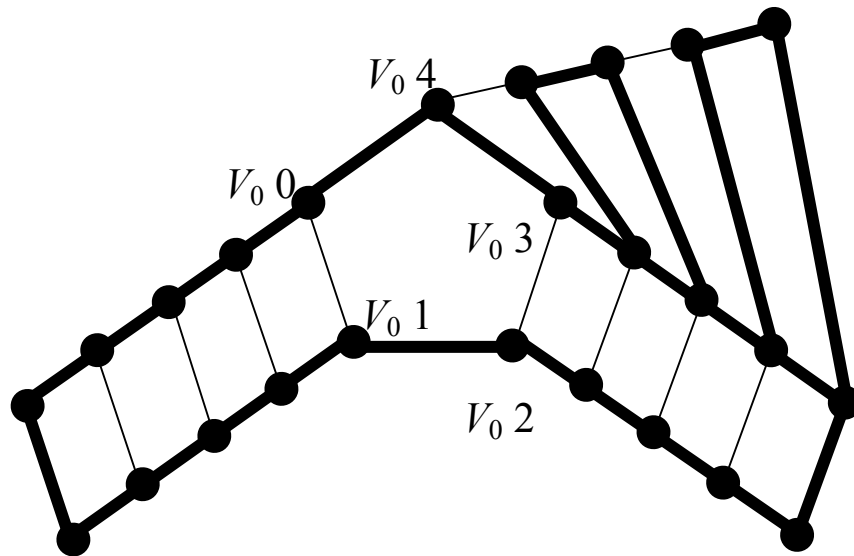

Figure 15. Embedding the cycle of ladders drawn by the bold lines into the $H(5, 2)$.